

SonoMeter 31

Ultrasonic energy meter
for heating and cooling applications





Danfoss A/S

DK 6430 Nordborg
Denmark
CVR nr: 20 16 57 15

Telephone: +45 7488 2222
Fax: +45 7459 0949

EU DECLARATION OF CONFORMITY

Danfoss A/S
Danfoss Energy Metering

declares under our sole responsibility that the product(s) Energy meters

Type(s): SONOMETER 31

EC type-examination certificate no.: LT-1621-M1004-023 (LEI Lithuanian energy Institute)



is in conformity with the relevant Union harmonisation legislation acts, as far as these apply to the product:

- MID Directive 2014/32/EU
- EMC Directive 2014/30/EU
- LVD Directive 2014/35/EU
- RTTE Directive 2014/53/EU

The product complies with the following used harmonised standards and normative documents, rules and technical guidelines (level as indicated):

- | | |
|--------------------------|--------------|
| EN 1434:2007 | EN-61000-4-3 |
| WELMEC 7.2:2009 | EN-61000-4-4 |
| EN 61010-1:2010 | EN-61000-4-5 |
| EN 55022:2010 | EN-61000-4-6 |
| EN 300 220-2 v2.4.1:2012 | EN-61000-4-8 |
| EN-61000-4-2 | |

The notified body LEI Lithuanian energy Institute, number 1621, surveils the quality system according module D / MID certificate no.:
Module D: KS-1621MP-001.15

Date: 1.8.2016	Issued by: Signature Name Title	Date: 1.8.2016	Approved by: Signature Name Title
	 Siniša Bogar Product Manager		 Bjarne Halbjør Sig Product Portfolio Director

Danfoss only vouches for the correctness of the English version of this declaration. In the event of the declaration being translated into any other language, the translator concerned shall be liable for the correctness of the translation

1. Installation

1.1. Preparation

Only qualified personnel may install the equipment, following the requirements listed in this document. More detailed instruction can be found on www.heating.danfoss.com.

Note! This product is approved for ambient temperature between 5-55°C, but to ensure optimal conditions for battery it is recommended to install Calculator at max. 45°C. Avoid installation stress from pipes and fittings. Flush the system.

1.2. Identification of installation: Return/Supply pipe installation and flow direction

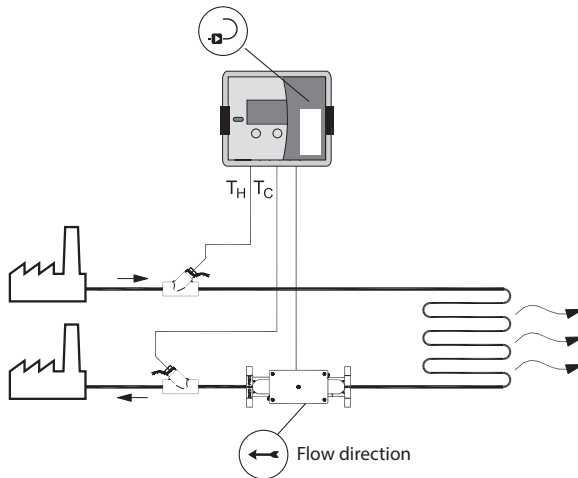

Return pipe installation

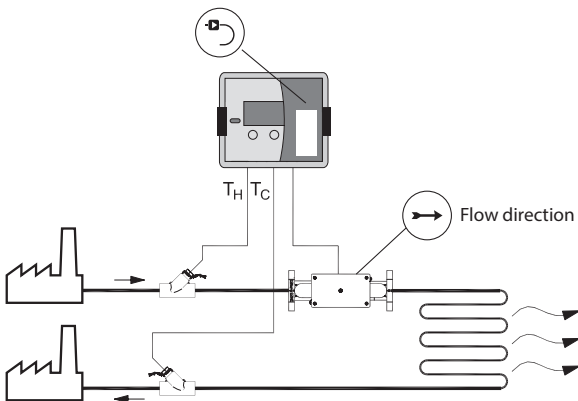

Supply pipe installation

1.3. Mounting of flow sensor

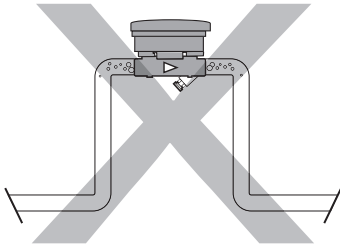

Pipe position: Avoid positions where air can be collected.

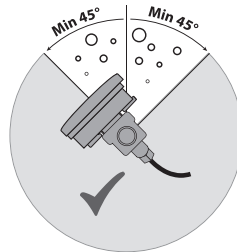

Rotation in pipe axis: Flow sensor should be angled in 45 to 315° to avoid air collection in flow sensor.

Inlet/outlet conditions

In order to maximize performance it is necessary to have straight inlet and outlet flow conditions before and after the flow sensor: 5 × DN on inlet and 3 × DN on outlet of flow sensor.

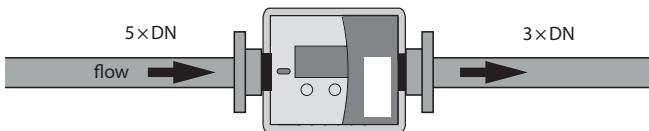

1.4. Mounting and sealing of calculator

On the wall:

Panel mounting on standard DIN-rail:

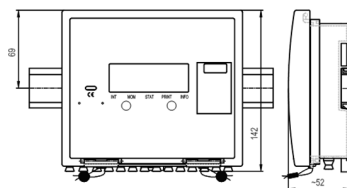
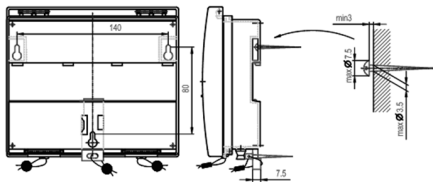

1.5. Mounting and sealing of temperature sensors

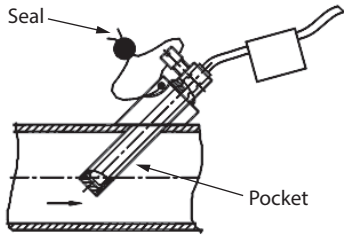

a) angled 45°

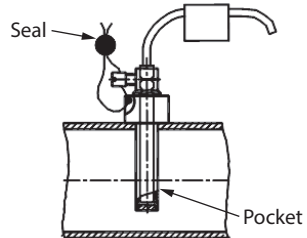

b) perpendicular

Installation recommendations for pocket temperature sensors with permanently connected signal leads.

2. Electrical wiring



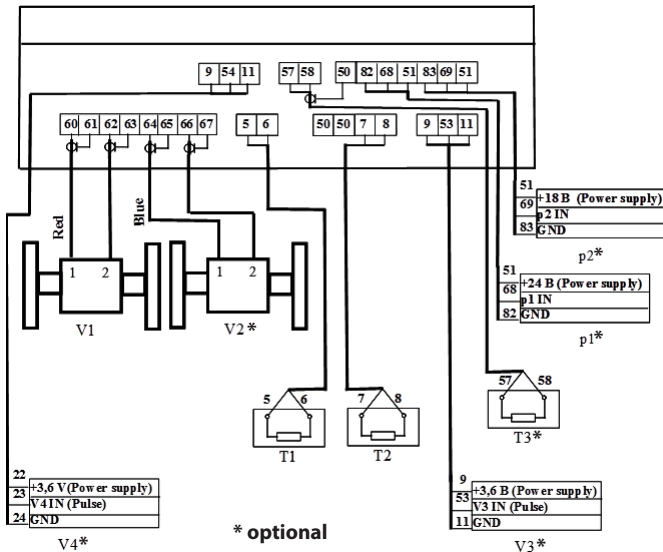

Electrical wiring diagram with 2-wire temperature sensors



- V1...V2 – ultrasonic flow sensors
- T1...T3 – temperature sensors
- V3...V4 – water meters with pulse output
- p1...p2 – pressure sensors

Remark: Only required for selected meter type is connected

Calculator

Terminals	Marking	Description
60	V1-1 (+)	Output signal (OUT) from 1st flow sensor V1
61	V1-1(-)	GND for output (OUT) of 1st flow sensor V1
62	V1-2 (+)	Input signal (IN) from 1st flow sensor V1
63	V1-2 (-)	GND for input (IN) of 1st flow sensor V1
64	V2-1 (+)	Output signal (OUT) from 2nd flow sensor V2
65	V2-1 (-)	GND for output (OUT) of 2nd flow sensor V2
66	V2-2 (+)	Input signal (IN) from 2nd flow sensor V2
67	V2-2 (-)	GND for input (IN) of 2nd flow sensor V2
1*	T1	Current terminal for 1-st temperature sensor "+I"
5	T1	Voltage terminal for 1-st temperature sensor "+U"
6	T1	Voltage terminal for 1-st temperature sensor "-U"
2*	T1	Current terminal for 1-st temperature sensor "-I"
50*		GND for temperature sensors
3*	T2	Current terminal for 2-nd temperature sensor "+I"
7	T2	Voltage terminal for 2-nd temperature sensor "+U"
8	T2	Voltage terminal for 2-nd temperature sensor "-U"
4*	T2	Current terminal for 2-nd temperature sensor "-I"
9	+	+3,6V power supply voltage for pulse inputs V3, V4
53	V3	Pulse input signal from 1-st input V3 (IN)
11		GND for V3 and V4 pulse inputs
54	V4	Pulse input signal from 2-nd input V4 (IN)
56*	T3	Current terminal for 3-rd temperature sensor "+I"
57	T3	Voltage terminal for 3-rd temperature sensor "+U"
58	T3	Voltage terminal for 3-rd temperature sensor "-U"
59*	T3	Current terminal for 3-rd temperature sensor "-I"
82		GND for pressure sensor p1
68	P1	Input signal from 1-st pressure sensor (IN)
51	+	+18 V power supply voltage for pressure sensors p1, p2
83		GND for pressure sensor p2
69	P2	Input signal from 2-nd pressure sensor (IN)

REMARK: * – only for 4-wire connection method of temperature sensors (K)

Communication modules

Terminal number	Marking	Description
76	⊥	GND for currency outputs
77	lout1	1st currency outputs (+)
78	lout2	2nd currency outputs (+)
79	⊥	GND for pulse outputs
80	Puls 1	1st pulse outputs (+)
81	Puls 2	2nd pulse outputs (+)
24 (73)	BUS	M-bus line L1
25 (74)	BUS	M-bus line L2
75	BUS	GND for communication interface RS-232
60	60	MODBUS module 12–24 V DC power terminal (bipolar)
61	61	MODBUS module 12–24 V DC power terminal (bipolar)
90	90	MODBUS module line (+)
91	91	MODBUS module line (–)

Power supply 230V AC

Terminal number	Marking	Description
26	⊥	Main ground
27	N	Neutral
28	L	Mains supply 230 V AC

3. Commissioning

3.1. Bleeding

1. Bleed the system until the flow rate display is steady.
2. Make sure no error codes are displayed.
3. Check the display for a plausible indication of flow rate and temperatures.

3.2. IP class

Calculator	IP65
Flow sensor	IP65 for heat meter IP67 for heat and cooling meter

4. Display function overview

4.1. Display symbols description

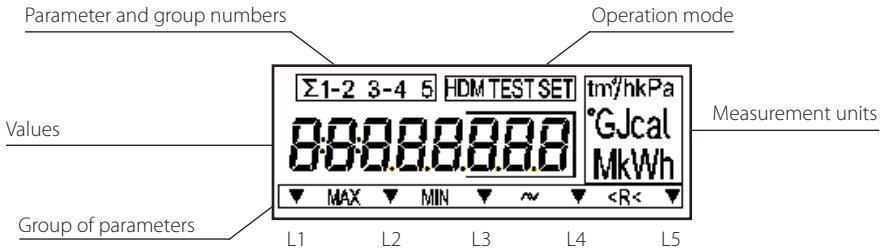

4.2. Menu structure

Parameters shown	Identification symbols				
Integral values	▼				
	L1	L2	L3	L4	L5
Instantaneous parameters values (L2)		▼			
	L1	L2	L3	L4	L5
Set day parameters and archive data values (L3)			▼		
	L1	L2	L3	L4	L5
Printing reports by standard printer (L4)				▼	
	L1	L2	L3	L4	L5
Configuration settings parameters (L5)					▼
	L1	L2	L3	L4	L5
Parametrization (configuration) mode (SET)			SET		
	L1	L2	L3	L4	L5
Test mode (TEST)			TEST		
	L1	L2	L3	L4	L5

4.3. Error codes

The meter continuously analyzes operational modes, diagnoses and informs of errors in system

Significant faults Er¹

If significant faults Er¹ are detected in work of heating system, energy calculation is stopping and these errors are displayed via 6 character error code:

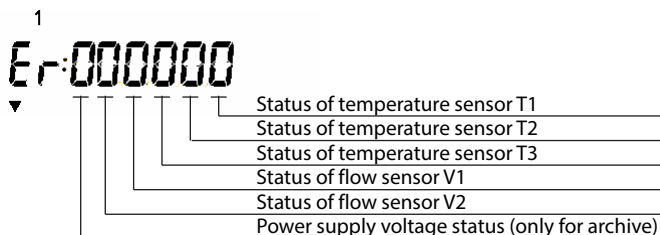

Detailed description of significant faults codes Er¹

Error display	Error description
Er1: 000000	No error. Normal mode
Er1: 000001	Fault in temperature $\Theta 1$ measuring circuit*: temperature difference $\Theta 1 - \Theta 2 < d\Theta_{min}$ ($d\Theta_{min}$ – the minimum value of temperature difference)
Er1: 000002	Fault in temperature $\Theta 1$ measuring circuit: temperature $\Theta 1 < 0\text{ }^{\circ}\text{C}$ (or sensor has short circuit)
Er1: 000004	Fault in temperature $\Theta 1$ measuring circuit: temperature $\Theta 1 > 180\text{ }^{\circ}\text{C}$ (or sensor has open circuit)
Er1: 000010	Fault in temperature $\Theta 2$ measuring circuit*: temperature difference $\Theta 1 - \Theta 2 < d\Theta_{min}$ ($d\Theta_{min}$ – the minimum value of temperature difference)
Er1: 000020	Fault in temperature $\Theta 2$ measuring circuit**: temperature $\Theta 2 < 0\text{ }^{\circ}\text{C}$ (or sensor has short circuit)
Er1: 000040	Fault in temperature $\Theta 2$ measuring circuit**: temperature $\Theta 2 > 180\text{ }^{\circ}\text{C}$ (or sensor has open circuit)
Er1: 000200	Fault in temperature $\Theta 3$ measuring circuit**: temperature $\Theta 3 < 0\text{ }^{\circ}\text{C}$ (or sensor has short circuit)
Er1: 000400	Fault in temperature $\Theta 3$ measuring circuit**: temperature $\Theta 3 > 180\text{ }^{\circ}\text{C}$ (or sensor has open circuit)
Er1: 002000	Fault in V1 measuring circuit*: flow rate $q_1 < q_{1i}$ (q_{1i} – the minimum allowable value of flow rate)
Er1: 004000	Fault in V1 measuring circuit*: flow rate $q_1 > q_{1s}$ (q_{1s} – the maximum allowable value of flow rate)
Er1: 008000	Fault in V1 measuring circuit: Fault in flow measuring channel
Er1: 020000	Fault in V2 measuring circuit*: flow rate $q_2 < q_{2i}$ (q_{2i} – the minimum allowable value of flow rate)
Er1: 040000	Fault in V2 measuring circuit *: flow rate $q_2 > q_{2s}$ (q_{2s} – the maximum allowable value of flow rate)
Er1: 080000	Fault in V2 measuring circuit: Fault in flow measuring channel
Er1: 100000	No supply voltage (only for data logger)

Note: * - only when non-standard energy calculation algorithm is applied

** - only in cases where the temperature sensors T2, T3 are used to calculate the thermal energy

Active error codes are added and simultaneously displayed

Transitory fault Er²

If transitory faults Er2 are detected in work of heating system, energy calculation do not stop and these errors are displayed via 5 character error code:

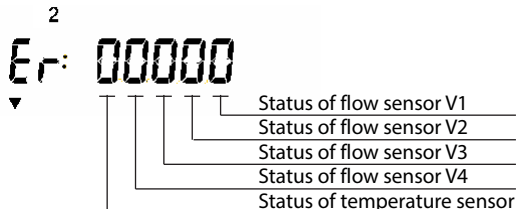

Detailed description of transitory faults codes Er²

Error display	Error description
Er2: 00000	No error. Normal mode
Er2: 00001	Flow q1 flow in reverse direction
Er2: 00002	Flow value q1 < q1, (the minimum allowable value of flow rate)
Er2: 00004	Flow value q1 > q1, (the maximum allowable value of flow rate)
Er2: 00008	Flow sensor V1 is not filled by a liquid
Er2: 00010	Flow q2 flow in reverse direction*
Er2: 00020	Flow value q2 < q2, (the minimum allowable value of flow rate)
Er2: 00040	Flow value q2 > q2, (the maximum allowable value of flow rate)
Er2: 00080	Flow sensor V2 is not filled by a liquid
Er2: 00100	On input V3 more than 24 hours do not arrive pulses**
Er2: 00200	Flow value q3 < q3, (the minimum allowable value of flow rate)
Er2: 00400	Flow value q3 > q3, (the maximum allowable value of flow rate)
Er2: 00800	Short circuit V3***
Er2: 01000	On input V4 more than 24 hours do not arrive pulses**
Er2: 02000	Flow value q4 < q4, (the minimum allowable value of flow rate)
Er2: 04000	Flow value q4 > q4, (the maximum allowable value of flow rate)
Er2: 08000	Short circuit V4***
Er2:10000	Temperature difference $\Theta_1 - \Theta_2 < d\Theta_{min}$
Er2:20000	Temperature difference $\Theta_1 - \Theta_2 < 0^\circ C$
Er2:40000	Temperature $\Theta_3 < -40^\circ C$ or sensor has short circuit****
Er2:80000	Temperature $\Theta_3 > 180^\circ C$ or sensor has open circuit****
Er2:50000	At the same time there are two error: "10000" and "40000"
Er2:60000	At the same time there are two error: "20000" and "40000"
Er2:90000	At the same time there are two error: "10000" and "80000"
Er2:A0000	At the same time there are two error: "20000" and "80000"

Note: * - Are not shown, when the algorithm 'winter / summer' is applied

** - only when flow input type "L" is on ("24 hours pulse control")

*** - only when flow input type "E" is on ("short circuit control")

**** - only when temperature measurement channel T3 is on

Active error codes are added and simultaneously displayed

5. Disposal



This symbol on the product indicates that it will not be treated as household waste. It must be handed over to the applicable take-back scheme for the recycling of electrical and electronic equipment. For more detailed information about the recycling of this product, please contact your local municipal office.

Item	Material	Disposal
Battery	D cell lithium/thionyl chloride 5,7 g lithium	Approved deposit for lithium batteries
PCBA with display	Coppered epoxy laminate components soldered on, PC, TPE	Electronic waste
Cables	Copper with PUR or PVC jackets	Cable recovery
Flow sensor (incl. transducer and liner)	Brass, stainless steel, PPS	Metal recovery
Transducer	PZT, stainless steel, PEI	Approved deposit for PZT
Other plastic parts	PC, PPS, PEI, TPE	Plastic recovery

Danfoss A/S

Energy Meters • Ulvehavevej 61 • DK-7100 Vejle • Denmark

Phone: +45 7488 8500 • Fax: +45 7488 8501

heating@danfoss.com • www.heating.danfoss.com

Danfoss can accept no responsibility for possible errors in catalogues, brochures and other printed material. Danfoss reserves the right to alter its products without notice. This also applies to products already on order provided that such alterations can be made without subsequential changes being necessary in specifications already agreed.
All trademarks in this material are property of the respective companies. Danfoss and the Danfoss logotype are trademarks of Danfoss A/S. All rights reserved.
